



Installation Instructions

818169

2021-2025 Ford F150
2.7L, 3.5L, or 5.0L Engine
Non-Hybrid or PowerBoost
With Factory Dual Exhaust



Installation requires moderate mechanical skill. If this job is beyond your abilities, seek the services of a qualified technician.

If you do not understand any part of these instructions, please call Flowmaster Technical Support at (866) 464-6553 for assistance.

Apply penetrating oil generously to clamps, fasteners, pipes, and hanger rods for ease of disassembly.

REVIEW THE INSTRUCTIONS & VERIFY THE KIT CONTENTS

Take a moment to read and understand these instructions before installing your Flowmaster exhaust kit.

Item#	Part #	Description	Qty.
1	26848S	Muffler Inlet Pipe	1
2	26277S	Muffler Inlet Pipe Extension	1
3	8430455-Z	Muffler	1
4	26930S	PowerBoost Muffler Inlet Pipe	1
5	26935S	Right Muffler Outlet Pipe	1
6	26936S	Left Muffler Outlet Pipe	1
7	26933S	Right Tailpipe	1
8	26934S	Left Tailpipe	1
9	ST509B	Black Ceramic Coated Tip	2
10	SF059B	Muffler Inlet Pipe Flange	1
11	490HA	Inlet Pipe Clamp Hanger	1
12	MC300BS	3" Band Clamp	6
13	HA168	Red Exhaust Hanger Isolator	1
14	HW102	5/16-18 Hex Nut	1
15	HW302	5/16 Flat Washer	1
16	HW502	7/16 Push Nut Retainer	2
17	535HA	Frame Hanger (Left Tailpipe)	1
18	HW204	5/16 x1" Bolt	1

Use the parts drawing and list to identify components and verify your kit's contents. In the unlikely event that any parts are missing, please contact Flowmaster Technical Support for replacements.

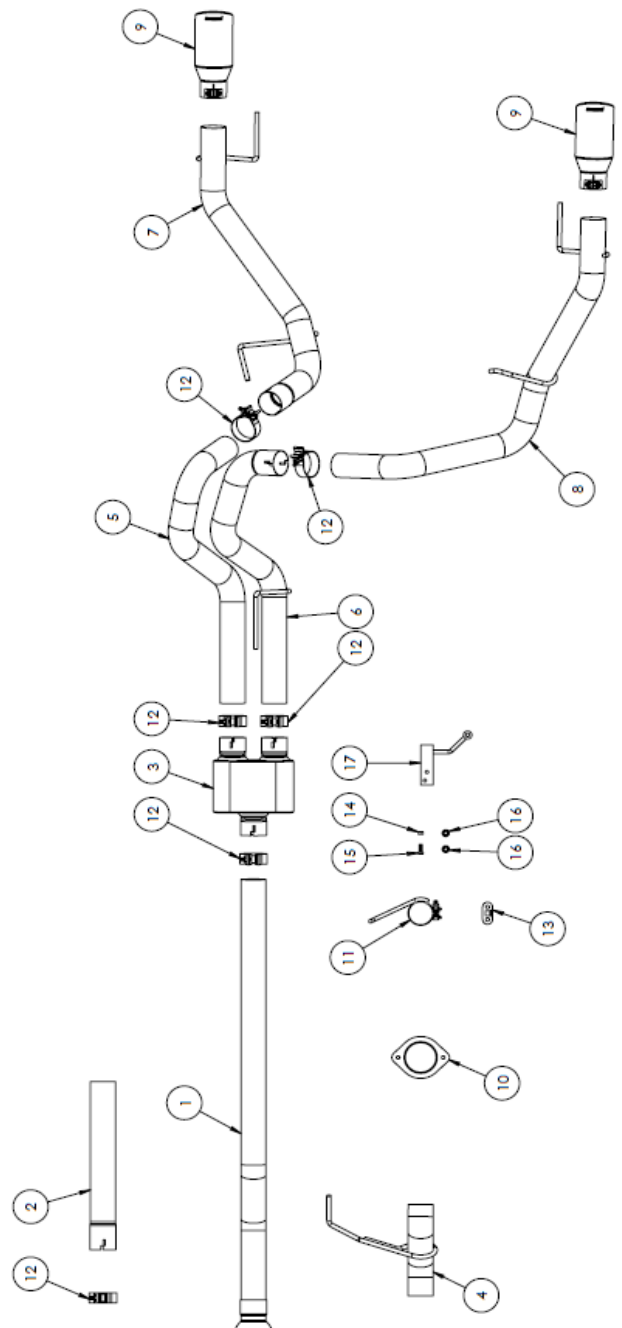

Vehicle Compatibility

Model Year: 2021-2025

Make: Ford F150

Engine: 2.7L, 3.5L, 5.0L V8

* Fits Non-Hybrid or PowerBoost trucks that were originally produced with optional Dual Exhaust out the rear bumper.

****Will not fit trucks originally produced with single side exit exhaust.**

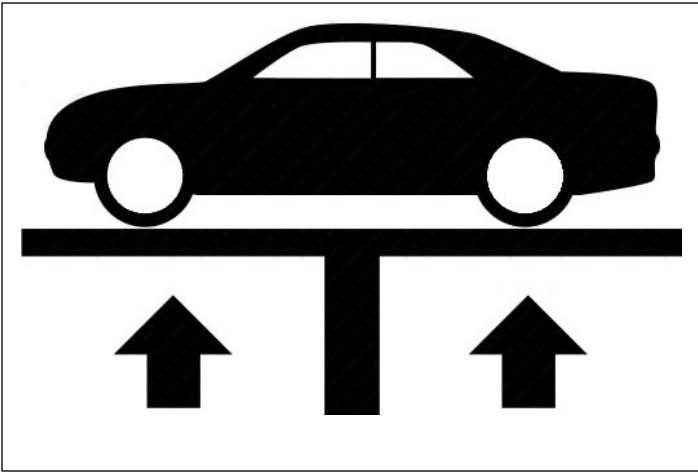

BEFORE STARTING:

Raise the vehicle to a minimum of eighteen inches. A floor hoist is ideal. If no hoist is available, we strongly urge the use of axle stands as a safety measure. **Please read and understand these instructions and disclaimer in their entirety before attempting installation.**

CAUTION! WORK ONLY ON A LEVEL SURFACE. USE JACKS /JACK STANDS OF SUFFICIENT CAPACITY TO LIFT AND SUPPORT YOUR VEHICLE. NEVER WORK UNDER A VEHICLE SUPPORTED BY A FLOOR OR BUMPER JACK.

Removing the OEM Exhaust:

NOTE: These instructions are written for both Non-Hybrid and PowerBoost trucks and illustrations are intended for reference only. Some images may be different from your vehicle. Please read and follow all instructions before attempting to install this exhaust system. Any details specific to the PowerBoost will be covered in detail, when necessary.

1. Apply penetrating oil to each rubber hanger on the exhaust.
2. Loosen the 15mm nuts on the tailpipe band clamps directly over the rear axle (Non-Hybrid shown). **Fig. 1**
3. Pry back the locking retainer using a small screwdriver.
4. Remove the M10 nuts securing the tailpipe extension hanger to the rear frame structure (trailer hitch assembly). **Fig.2**
5. Support the tailpipes.
6. Apply liberal amounts of spray lube to the slip joint at the band clamps.

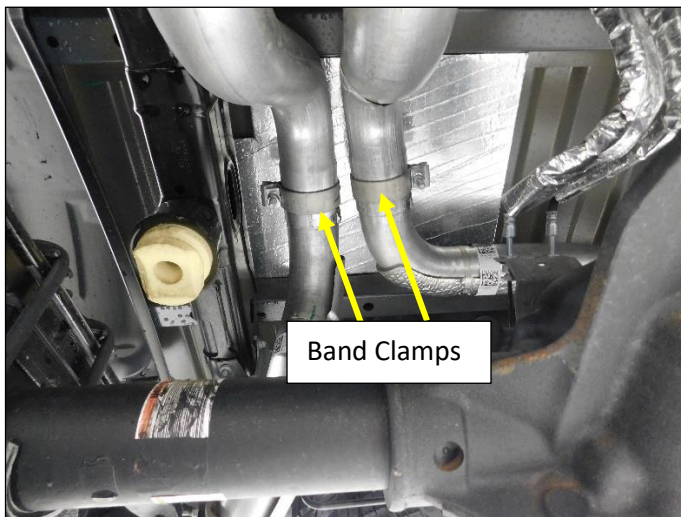

Figure 1

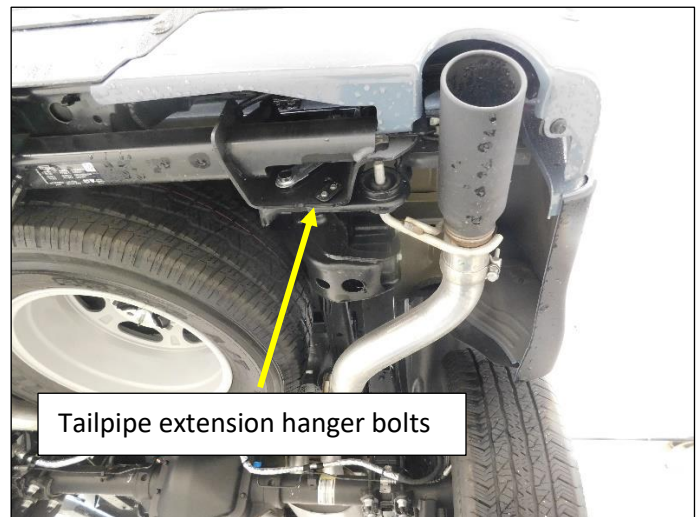

Figure 2

Removing the OEM Exhaust Continued

7. Remove the (x2) bolts from the left and right tailpipe hangers at the frame rails. **Fig. 3**

Note: PowerBoost driver's side frame hanger will have (x2) bolts on the inside of the frame rail. **Fig. 4**

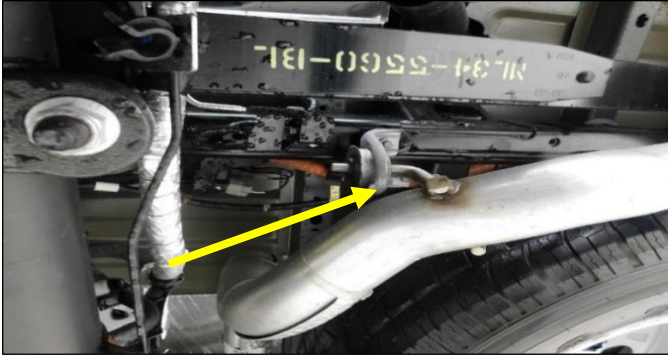

Figure 3



Figure 4

8. Remove the left and right tailpipes from the vehicle.

Note: Removing the spare tire will make the process less difficult, but is not necessary.

Non-Hybrid Muffler Removal

9. Loosen the clamp at the slip joint between the muffler and the resonator **(A)**. **Fig. 5**
10. Support the muffler with a jack stand.
11. Remove the (x2) bolts at the muffler hanger on the frame rail **(B)**. **Fig. 5**
12. Remove the bolt from the muffler hanger over the muffler and remove the hanger from the cross brace **(C)**. **Fig. 5**
13. Remove the muffler from the vehicle by sliding the muffler rearward off the resonator pipe.
14. Remove the bolts from the flange at the resonator inlet pipe and remove the resonator **(D)**. **Fig. 5**

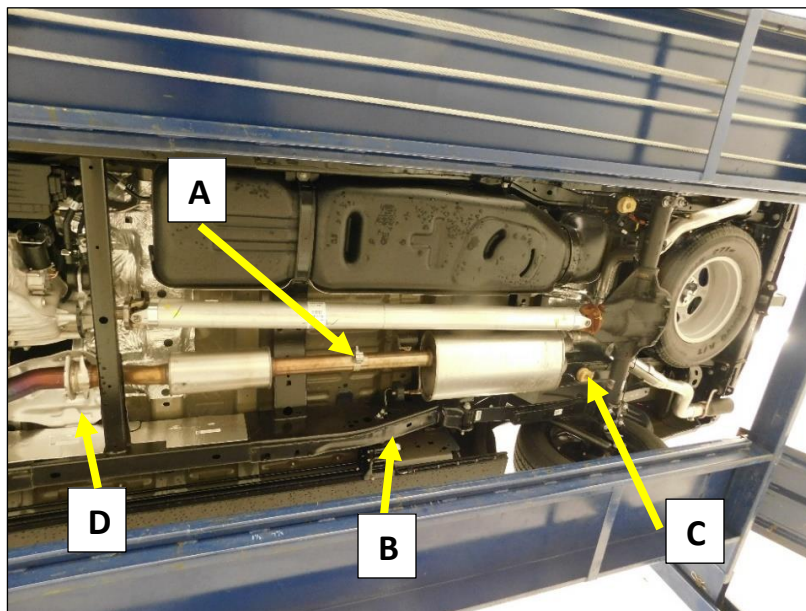

Figure 5

Removing the OEM Exhaust Continued

PowerBoost Muffler Removal

- Loosen the clamp at the slip joint between the muffler and the resonator (A). Fig .6
- Support the muffler and the resonator with a jack stand.
- Remove the (x3) bolts at the muffler hanger on the frame rail (B). Fig. 6
- Remove the bolt from the muffler hanger over the muffler and remove the hanger from the cross brace (C). Fig. 6
- Remove the muffler from the vehicle by releasing the locking clip and sliding the muffler rearward and out of the resonator pipe.

NOTE: Apply spray lube to the slip joint before removal.

Important: Continue to support the resonator after the muffler is removed and during installation of the Flowmaster Exhaust to prevent damage to the flex joint in the system.

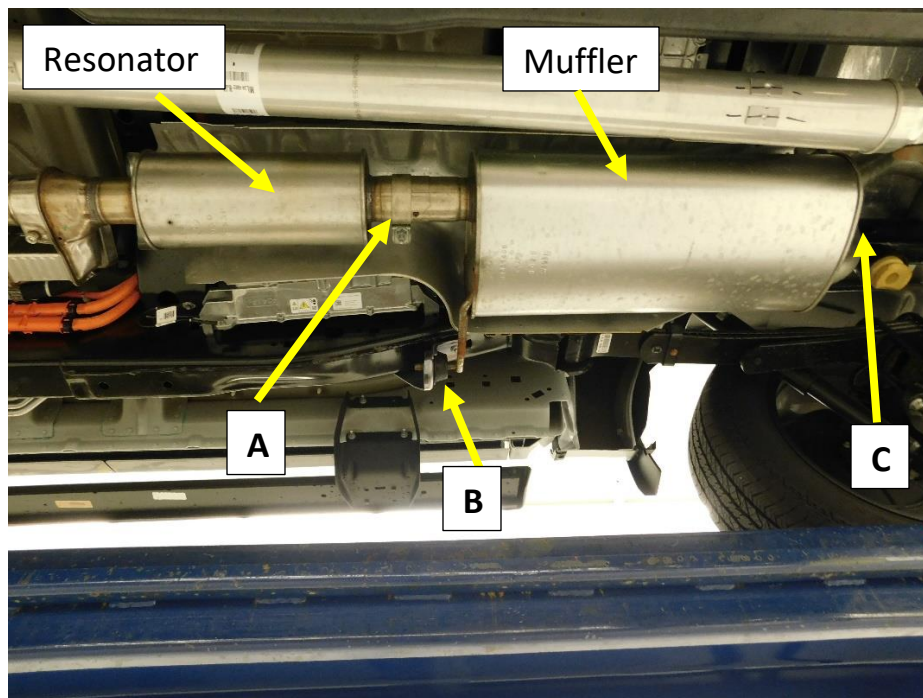

Figure 6

INSTALL YOUR FLOWMASTER EXHAUST SYSTEM



Before installing clamps in the following steps, remove their nuts, apply anti-seize compound to the bolt threads, and re-install the nuts.

- Determine if using the supplied muffler inlet extension pipe will be necessary by using the reference chart.

Muffler Inlet Extension Pipe Reference Chart

Wheelbase	Body Style	Bed Length	Inlet pipe configuration	Trim Requirement
145"	Super Crew	5.5'	Inlet Pipe only	None
145"	Super Cab	6.5'	Inlet Pipe only	None
157"	Super Crew	6.5'	Inlet + Extension	Trim 6" From Extension
163"	Super Cab	8'	Inlet + Extension	None

Non-Hybrid Muffler Inlet Pipe Installation – (See PowerBoost next page)

- Install the muffler hanger (B) **Fig. 5/7** on the frame rail in the same location it was removed.
- Install the 2-bolt flange (10) on to the muffler inlet pipe (1) with the machined edge towards the flare. **Fig. 7**
- Install the muffler inlet pipe on to the Y-pipe using the bolts removed from the factory exhaust. **Fig. 7**
- * Install the extension pipe if used on to the outlet of the muffler inlet pipe and secure with a 3" band clamp.
- Install the supplied clamp hanger (11) on to the muffler inlet pipe (1) and align with the frame hanger (B). Install the rubber isolator on to the hanger rods and tighten the clamp. **Fig. 7**

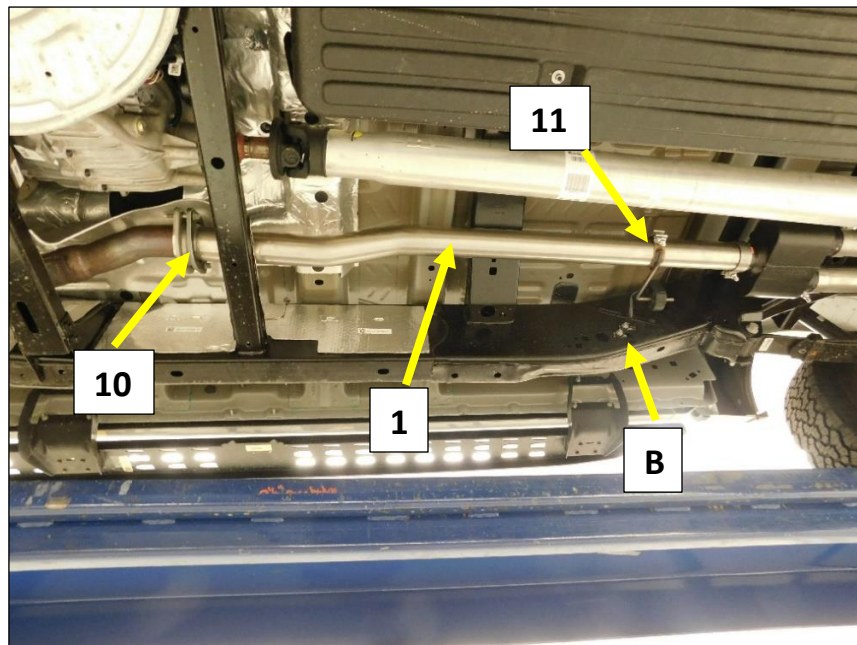

Figure 7

Installation Exhaust Continued

PowerBoost Muffler Inlet Pipe Installation

1. Install the muffler inlet pipe (4) into the resonator. **Fig. 8**
2. Install the muffler frame hanger (B) on to the inlet pipe hanger rod. Install the (x3) bolts and tighten. **Fig. 8**
3. Tighten the OEM clamp at the resonator to allow for adjustment. **Fig. 8**

NOTE: If Required - Install the muffler Inlet extension pipe between the resonator and muffler inlet pipe (4) using the supplied 3" band clamp.

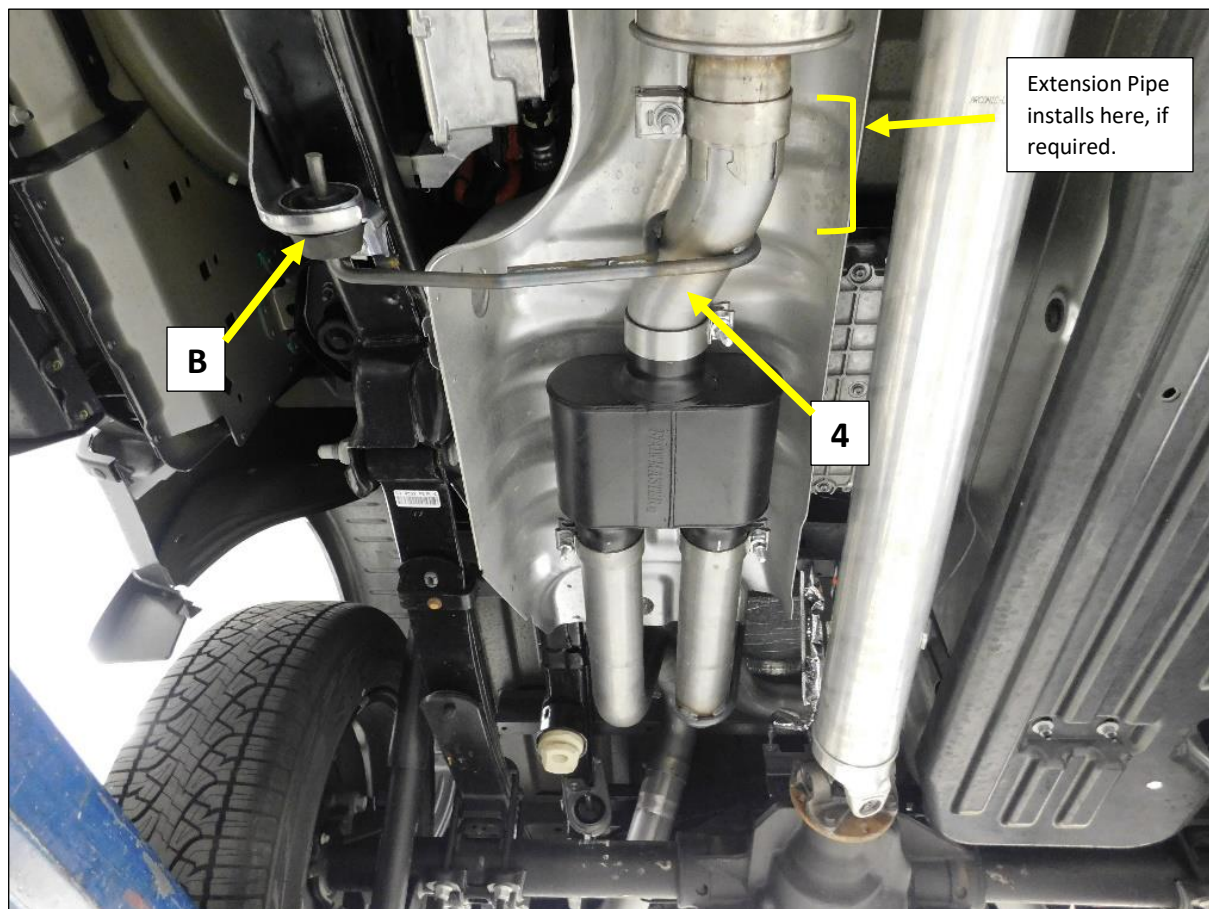

Figure 8

Installation Exhaust Continued

Non-Hybrid and PowerBoost Muffler and Tailpipe Installation

1. Install a 3" band clamp (12) on to each of the three-muffler inlet and outlet pipes with the bolt to the outside and the nut facing down. **Fig. 9**
2. Install the American Thunder Muffler (3) on to the muffler inlet pipe with the Flowmaster logo facing the ground. **Fig. 9**
3. Tighten the inlet clamp (12) to allow for adjustment.
4. Reinstall the muffler hanger assembly (C). * Be sure the tab is in the slot (not the round hole). **Fig. 9**
5. Install the left Muffler Outlet Pipe (6) into the muffler while guiding the hanger rod into the isolator(C). **Fig. 9**
*Some adjustment of the muffler inlet pipe at the flange may be necessary for best alignment of the hanger.
6. Install the Right Muffler Outlet pipe (5) into the muffler and tighten the clamp to allow for adjustment. **Fig. 9**

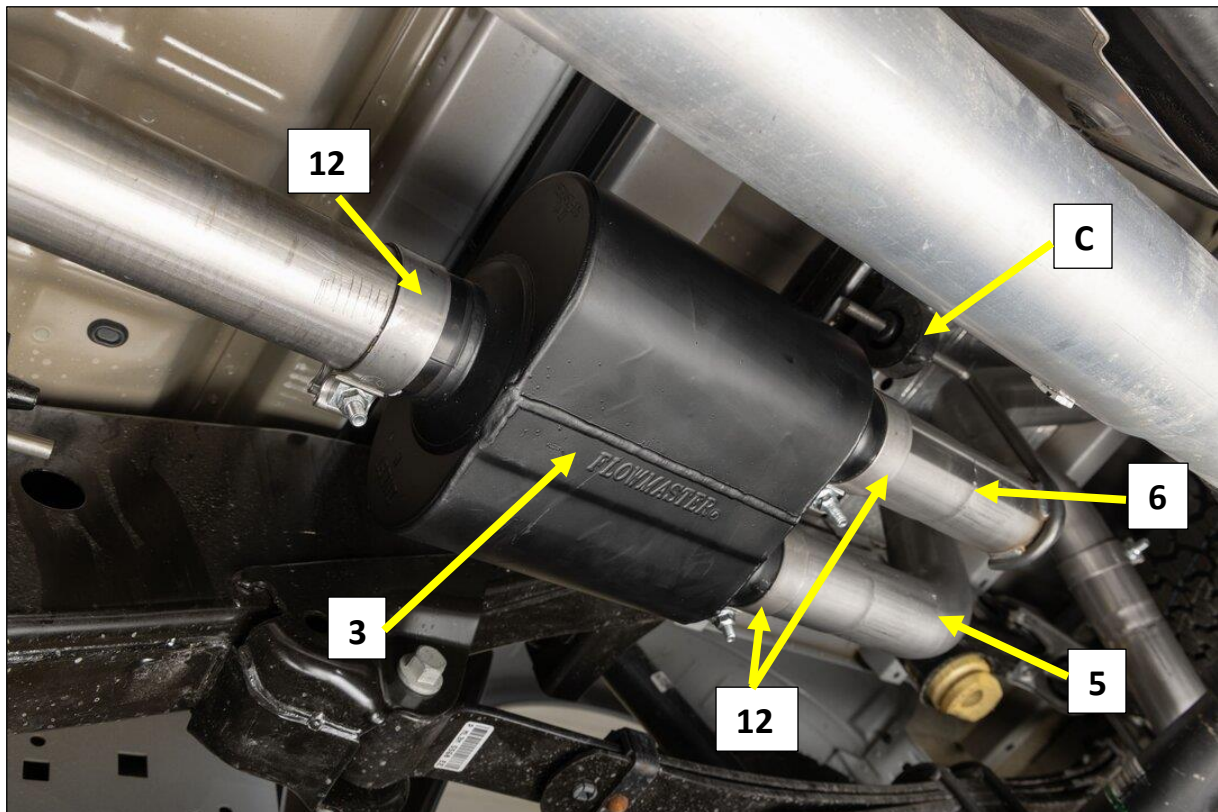

Figure 9

Installation Exhaust Continued

Assemble the Left Tailpipe Frame Hanger Assembly

The FACTORY left side tailpipe frame hanger assembly will not be used for Non-Hybrid or PowerBoost models. The Flowmaster frame hanger 535HA (17) will be installed in its place. It will be necessary to relocate the factory clip nut to a different location in the frame rail if it is not already there. Most standard F150 frame hanger assemblies use the correct location. PowerBoost vehicles will need the clip nut relocated as shown in Figures 11 & 12.

1. Install the 5/16-18 x 1 bolt (18) with 5/16 flat washer (15) and 5/16-18 nut (14) into the outer hole in the frame hanger mounting plate. **Fig. 10**

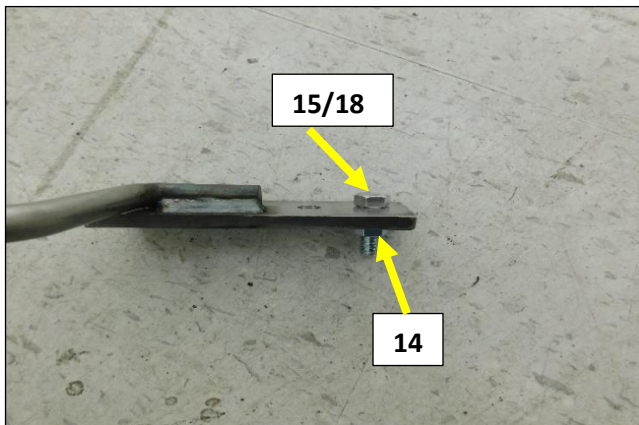

Figure 10

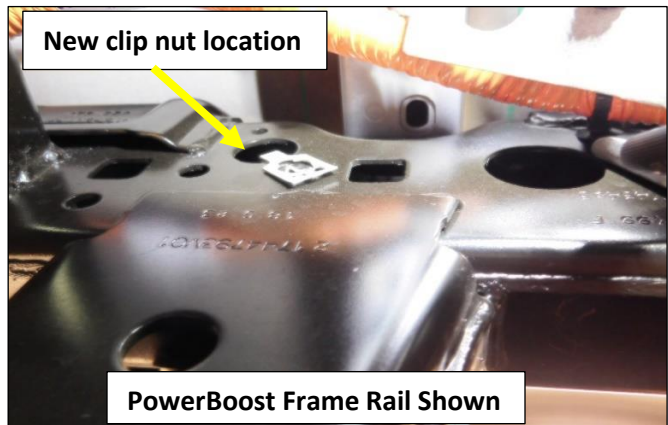

Figure 11

2. Remove one of the existing frame hanger clip nuts and re-install it into the frame rail at the location in **Fig. 11**. **NOTE:** Standard F150 models may already be in the correct location. PowerBoost clip nuts will move from the bottom of the frame rail to directly above and to the inside of the frame rail as shown. See **Fig. 12** as reference.
3. Install the 535HA (17) frame hanger on to the inside left frame rail using the OEM mounting bolt. **Fig. 12**

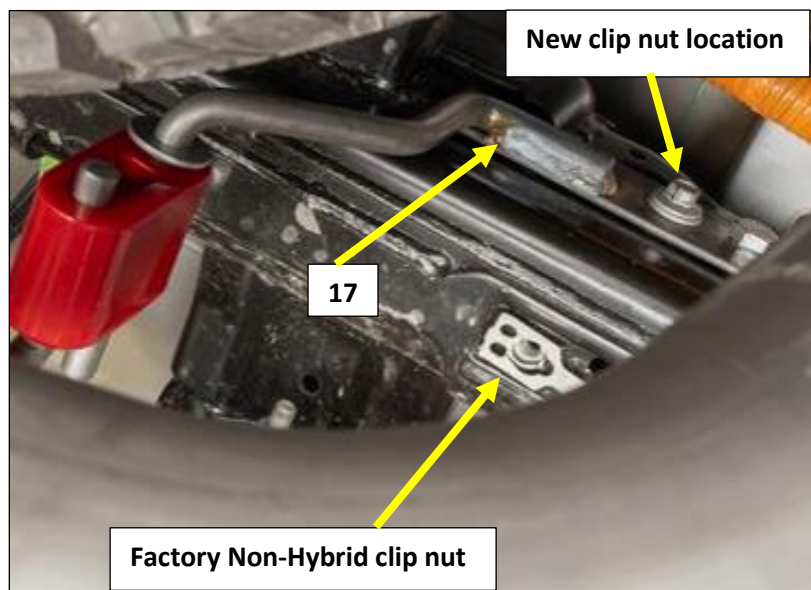

Figure 12

Installation Exhaust Continued

Installing the Tailpipes

1. Install a 3" band clamp (12) on to the expanded end of the left muffler outlet pipe (6). Install the 3" clamp (12) with the bolt towards the rear of the truck and the nut facing down. **Fig. 13**
2. Install the left tailpipe (8) into the left muffler outlet pipe (6), align the hanger rods at the frame hanger, and install the red isolator (13). Use Spray lube on the rods. **Fig. 13** - Tighten the clamp to allow for adjustment.

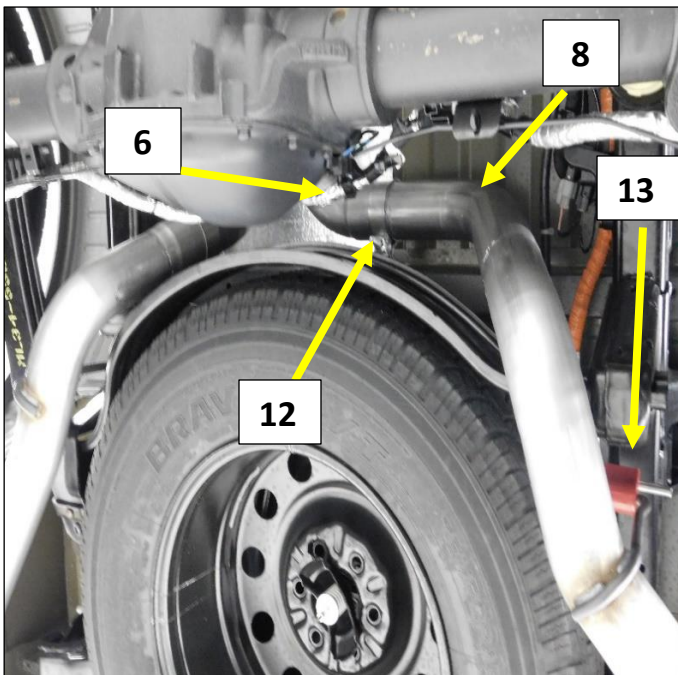

Figure 13

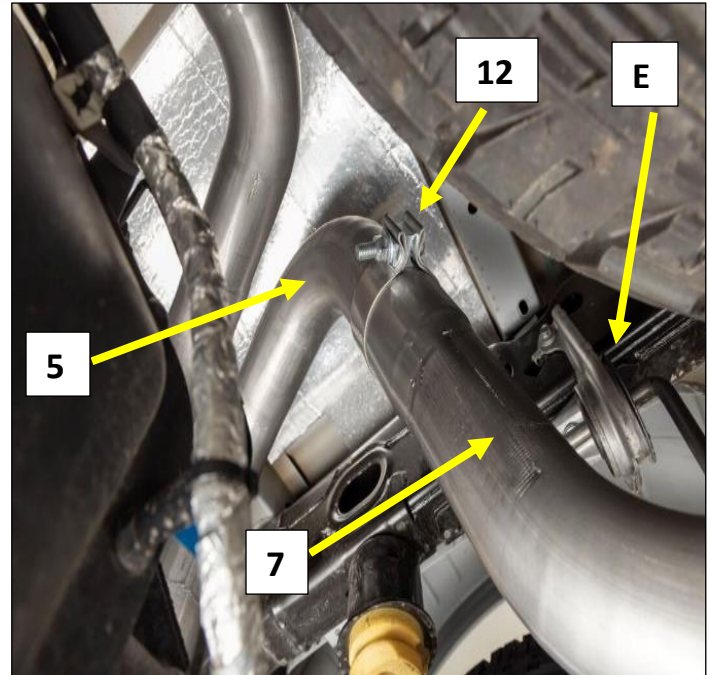

Figure 14

3. Install a 3" band clamp (12) on to the expanded end of the right tailpipe. **Fig. 14**
4. Install the right tailpipe (7) on to the right muffler outlet pipe (5). **Fig. 14**
5. Install the right frame hanger (E) on to the tailpipe hanger rod. Install the (x2) bolts. **Fig. 14**
6. Tighten the clamp (12) to allow for adjustment. **Fig. 14**

Installation Exhaust Continued

7. Install the Left (F) and Right (G) rear tailpipe hanger assemblies on to the rear tailpipe hanger rods. Install the stud plates into the rear frame bracket and install the nuts. **Fig. 15/16**
8. Tighten the nuts to allow for adjustment.

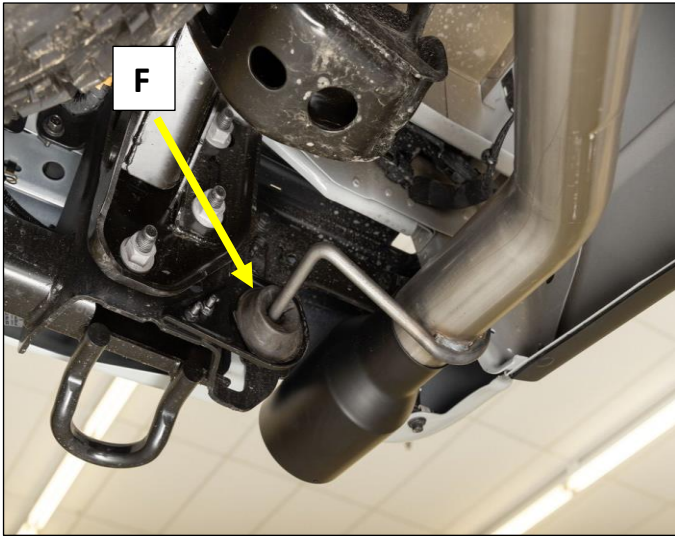

Figure 15

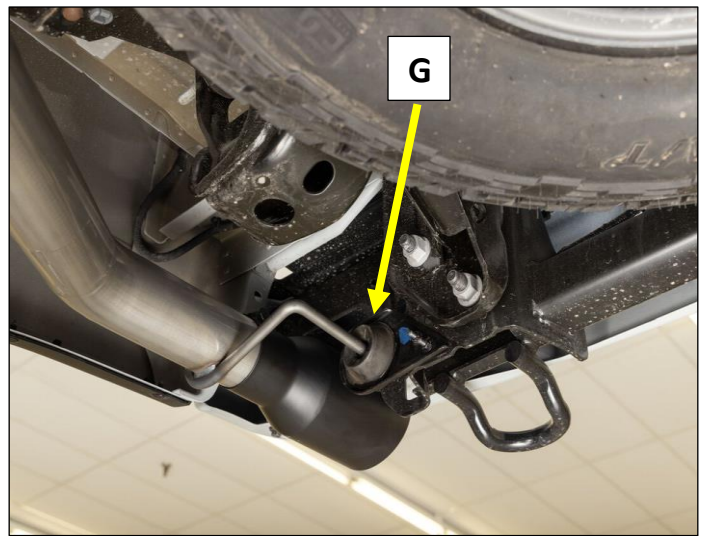

Figure 16

9. Align and adjust the system for best fit and component clearance starting at the front and working your way to the rear. Tighten the band clamps and all hardware as you go. Readjusting of components may be necessary after the first pass through the system.
10. Adjust the tip alignment in the bumper cut outs as the final adjustment.
11. Install the clip nuts (16) to the hanger rods and red isolator to keep them in place.
12. Adjustment to the system may need to be made after the first several driving cycles.





Enjoy Your Flowmaster Exhaust!